

Economic control of air conditioning using Triggers and Actions

There are many situations where equipment may be turned off to save energy when the building is unoccupied.

In this application we control the air conditioning by monitoring the state of the intruder alarm and shutting down the air conditioner when the alarm is set.

Net2 makes use of the events from the intruder alarm integration function and uses an I/O board controlled by Triggers and Actions rules.



Installing the hardware

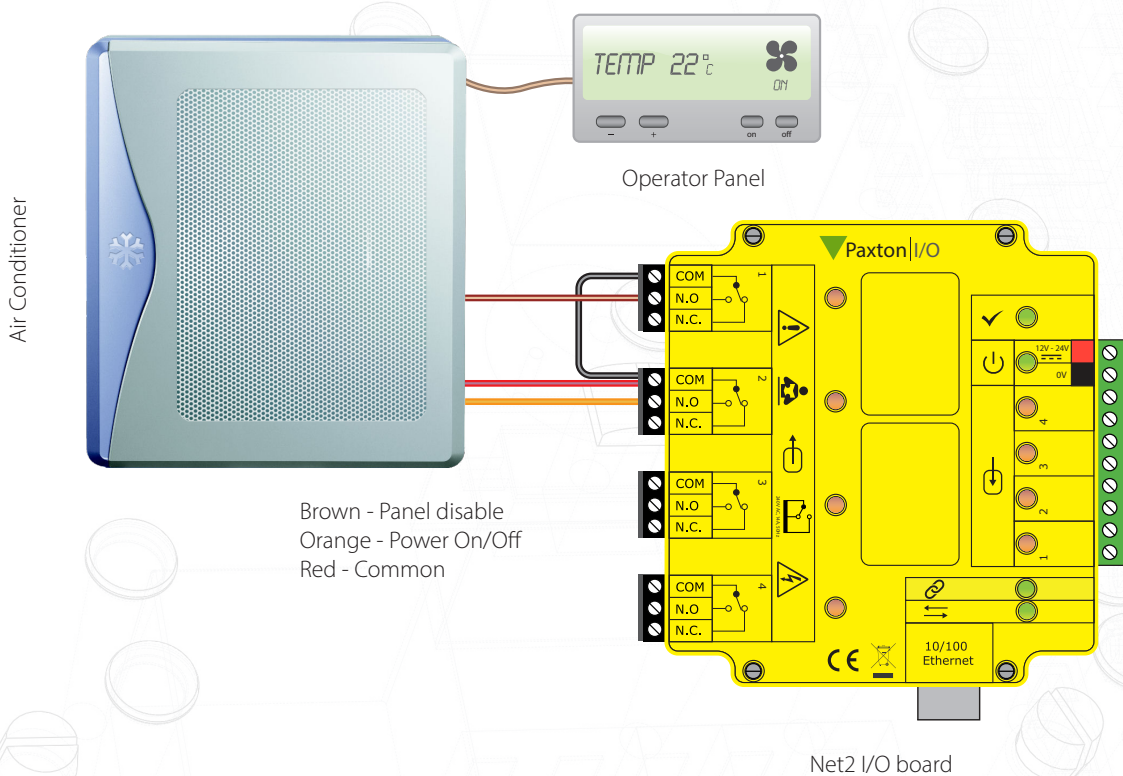

Many air conditioning units have an external interface. In this example we must first disable the operator panel by linking the Red and Brown wires and then break any link between the Red and Orange wires to turn off the unit. Many other options exist depending on your manufacturer but the principles explained here are the same.

Wire the two control functions into two I/O relays.

I/O boards must first be configured before setting up any Triggers and Actions.

See also: [AN1066 - Installing an I/O board < http://paxton.info/506 >](http://paxton.info/506)

Setting up rules for Triggers and Actions

In this example we will turn off the air conditioning by using the setting of the intruder alarm as the trigger.

This requires the operator panel to be disabled, break any connection across the power control wires and then return control to the operator panel ready for use the next day.

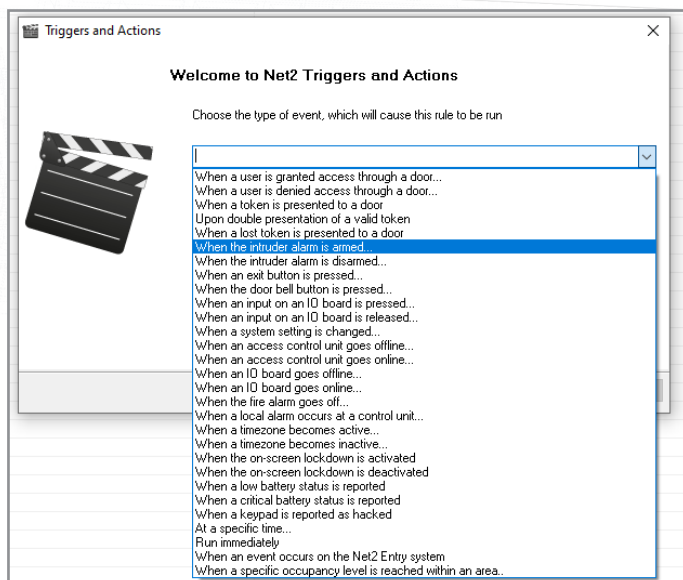

Select Triggers and Actions from tree view. Click 'Add' - The title page displays - Click 'Next'!

Select 'When the intruder alarm is armed'.

Click 'Next'!

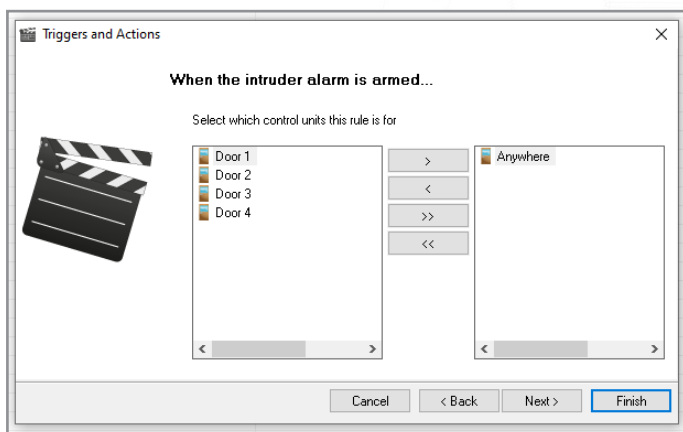

Select which ACU has intruder alarm integration. This can be set to 'Anywhere', or select the specific ACU's in that area.

Click 'Next'!

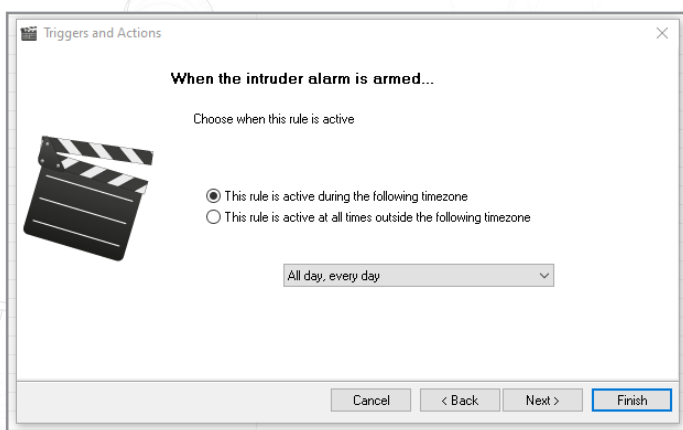

Select the relevant timezone from the menu.

Our example shows 'All day, everyday' as the selected timezone.

Click 'Next'!



Select 'No delay'

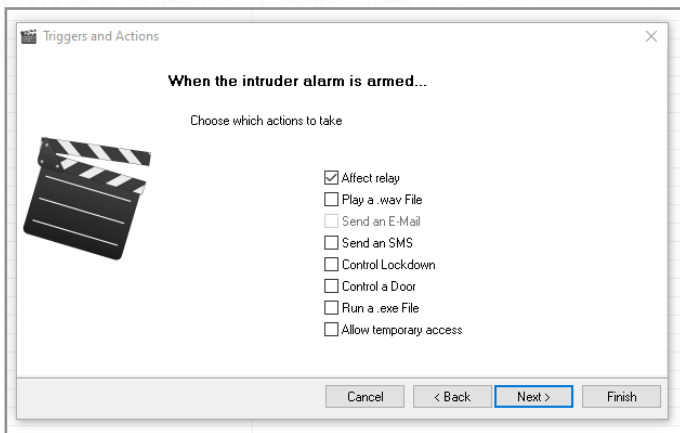

Select 'Affect relay'

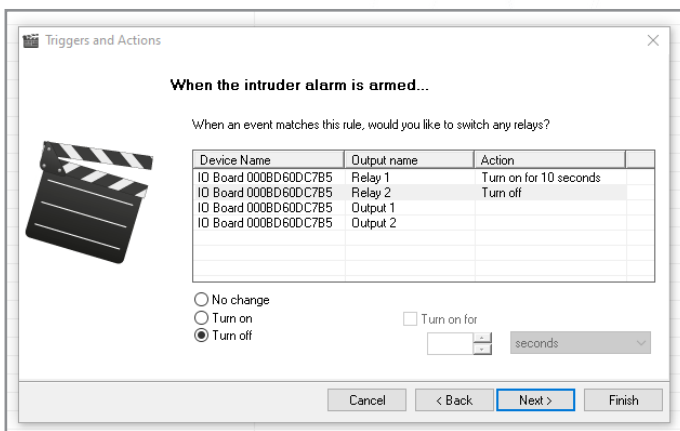

Turn on Relay 1 to disable the operator panel for 10 seconds.

Turn off Relay 2. This ensures that the Red/Brown connection is broken even if it has previously been turned on by another rule.

Click 'Next'.

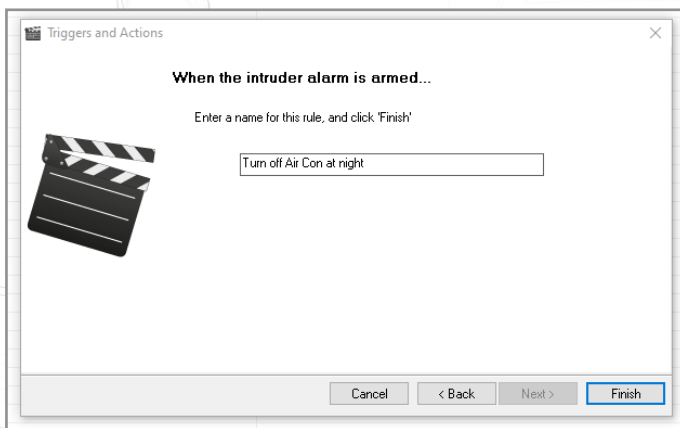

Give the rule a descriptive name and click 'Finish' to save.

Important

For Triggers and Actions to function correctly, the Net2 server must be running at all times.