

# Paxton10 - Turret Camera Junction Box

## Overview

The camera junction box enables a simple, tidy installation for the Paxton10 cameras. Concealing the cables connected to the camera provides an aesthetically pleasing finish.

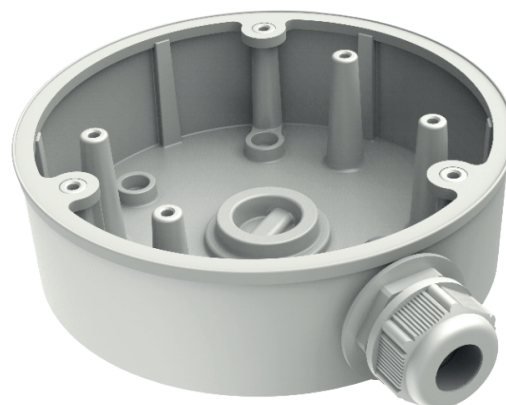

## Features

- Simplifies camera installations
- Weatherproof
- Paxton's 5 year warranty

## Specifications



### Hardware

Dimensions (W x H x D)	Ø132mm x 42mm
Weight	250g
Material	Aluminum Alloy
Warranty	Paxton 5 year



### Environment

Mounting	On a flat surface
----------	-------------------



### Accessories and Sales codes

010-445-EX	Paxton10 - Turret Camera Junction Box
010-480-EX	Paxton10 - Turret Camera, PRO series
010-705-EX	Paxton10 - Turret camera, CORE series